

VIA



PL

Innowacyjna oprawa drogowa VIA z nowoczesnym układem zasilania o doskonałych parametrach użytkowych. Wyróżnia się układem optycznym niwelującym ośnienie oraz szybą hartowaną. Do wyboru dostępne jest 6 rodzajów optyk, optymalnych dla różnych sytuacji drogowych. Zastosowane wysokowydajne moduły LED o skuteczności świetlnej do 155 lm/W w najnowszej technologii zapewniają ekstremalnie wysoką żywotność >100 000 godzin. Istnieje możliwość pełnego sterowania oprawą (SmartCity). Wysoka jakość i bezpieczeństwo produktu potwierdzona europejskimi certyfikatami ENEC oraz ENEC+. Oprawa jest zgodna ze standardem Zhaga D4i.

EN

Innovative VIA road luminaire with a proprietary power supply system with excellent performance parameters. It is also distinguished by a high quality optical system that reduces glare and a tempered glass. There are six types of optics to choose from, optimal for different road lighting classes. The high-performance LED modules used have light efficacy up to 155 lm/W in the latest technology ensure extremely long lifetime >100,000 hours. It is possible to fully control the luminaire (SmartCity). High quality and safety of the product confirmed by the European ENEC and ENEC+ certificates. The luminaire is compliant with the Zhaga D4i standard.

DE

Innovative Straßenleuchte VIA mit modernem Stromversorgungssystem mit hervorragenden Leistungsparametern. Es zeichnet sich durch ein optisches System zur Blendungsreduzierung und ein gehärtetes Glas aus. Es stehen 6 Optiktypen zur Auswahl, die für verschiedene Klassen der Straßenbeleuchtung optimal sind. Die verwendeten Hochleistungs-LED-Module mit der Lichtausbeute von bis zu 155 lm/W in neuester Technologie sorgen für eine extrem lange Lebensdauer von > 100.000 Stunden. Es ist möglich, die Leuchte vollständig zu steuern (SmartCity). Hohe Qualität und Sicherheit des Produkts werden durch die europäischen Zertifikate ENEC und ENEC+ bestätigt. Die Leuchte ist konform mit dem Zhaga D4i Standard.

OPCJE DO WYBORU / OPTIONS / OPTIONSWAHL MÖGLICH:



OP1, OP2, OP3, OP4, OP5, OP6



Tc 4000K



szary/gray/grau RAL7035

PARAMETRY TECHNICZNE / TECHNICAL PARAMETERS OPCJE DO WYBORU / TECHNISCHE DATEN:

Sposób montażu: na słupie $\varnothing 48-60$ mm
 Obudowa: ciśnieniowy odlew aluminiowy
 Klosz: szyba hartowana
 LED: 3 elipsa MacAdama (SDCM 3)
 ULOR = 0,0%
 Napięcie zasilania: 220-240 V / 50/60 Hz Współczynnik mocy (PF): 0,98
 Prąd rozruchowy: $I_{NRUSH} = 45$ A
 Miganie procentowe (FP): 1,2%
 Indeks migotania (Fi): 0,002
 Widoczny efekt stroboskopowy (SVM): 0,03
 Poziom zakłóceń harmonicznych THD < 6,5%
 Tolerancja mocy elektrycznej: +/- 5%
 Maks. liczba opraw z bezpiecznikiem: (Patrz tabela na stronie 4)

Mounting: on pillar $\varnothing 48-60$ mm
 Body: aluminum die casting
 Lampshade: tempered glass
 LED: MacAdam 3 ellipse (SDCM 3)
 ULOR = 0,0%
 Power Supply: 220-240 V / 50/60 Hz
 Power factor (PF): 0,98
 Inrush current: $I_{NRUSH} = 45$ A
 Percent Flicker (FP): 1,2%
 Flicker index (Fi): 0,002
 Stroboscopic Visibility Measure (SVM): 0,03
 Harmonic distortion THD < 6,5%
 Electrical power tolerance: +/- 5%
 Max. number of luminaires with protection: (See table on page 4)

Montageart: auf den Pfosten $\varnothing 48-60$ mm
 Gehäuse: Aluminium-Druckguss
 Lampenschirm: gehärtetes Glas
 LED: MacAdam 3-Ellipse (SDCM 3)
 ULOR = 0,0%
 Speisespannung: 220-240 V / 50/60 Hz
 Leistungsfaktor (PF): 0,98
 Einschaltstrom: $I_{NRUSH} = 45$ A
 Prozent Flicker (FP): 1,2%
 Flicker-Index (Fi): 0,002
 Strobe-Effekt (SVM): 0,03
 Harmonische Verzerrung THD < 6,5%
 Toleranz der elektrischen Leistung: +/- 5%
 Maximale Anzahl Leuchten mit Schutz: (Siehe Tabelle auf Seite 4)

Klasa ochronności: II
 Wskaźnik oddawania barw CRI(Ra): >70
 Stopień wytrzymałości mechanicznej: IK09
 Stopień ochrony obudowy: IP66
 EPA (Effective Projective Area):
 VIA L <0,034 m² / VIA M <0,027 m²
 Pełny zakres regulacji kąta nachylenia oprawy: 120°*
 Temperatura otoczenia: od -40°C do +50°C
 Wilgotność otoczenia: 20-80%
 Trwałość (L90B10): 100 000 h w odniesieniu do temperatury Tc = 85° C oraz Tc = 105°C
 Ochrona przeciwprzebiecowa: 6 kV / 10 kV
 Funkcje SmartCity: 1-10V, astroDIM, astroDIM+
 Inne cechy: dostęp beznarzędziowy, budowa 2-komorowa, szybkozłączki WAGO
ZASTOSOWANIE: autostrady, ulice, parkingi, place, tereny zewnętrzne itp.

Protection class: II
 Colour rendering index CRI(Ra): >70
 Impact protection marking: IK09
 Protection marking: IP66
 EPA (Effective Projective Area):
 VIA L <0,034 m² / VIA M <0,027 m²
 Full range of luminaire tilt angle adjustment: 120°*
 Ambient temperature: from -40°C to +50°C
 Ambient humidity: 20-80%
 Lifetime (L90B10): 100 000 h at a temperature of Tc = 85°C and Tc = 105°C
 Surge protection: 6 kV / 10 kV
 SmartCity features: 1-10V, astroDIM, astroDIM+
 Other features: tool-free access, 2-chamber body, WAGO connectors
APPLICATION: motorways, streets, car parks, squares, outdoor area etc.

Schutzklasse: II
 Farbwiedergabe Faktor CRI(Ra): >70
 IK-Stoßfestigkeitsgrad: IK09
 Schutzklasse: IP66
 EPA (Effective Projective Area):
 VIA L <0,034 m² / VIA M <0,027 m²
 Voller Neigungsbereich der Leuchte: 120°*
 Umgebungstemperatur: von -40°C bis +50°C
 Umgebungsluftfeuchtigkeit: 20-80%
 Lebensdauer (L90B10): 100.000 Stunden bei einer Temperatur von Tc = 85°C und Tc = 105°C
 Überspannungsschutz: 6 kV / 10 kV
 Smart-City-Funktionen: 1-10V, astroDIM, astroDIM+
 Weitere Merkmale: werkzeugloser Zugang, 2-Kammer-Körper, WAGO-Anschlüsse
EINSATZBEREICH: Autobahnen, Straßen, Parkplätze, Plätze usw.

*Dokładna rozpiska ilości oraz bezpieczników na stronie 4. / The exact number and fuse list is on page 4. / Die genaue Nummer und Sicherungsliste finden Sie auf Seite 4.

PRODUKTY / PRODUCTS / PRODUKTE:



EAN	CODE	[W]	[K]	-	[lm]	[lm/W]
model: VIA M						
5904441711967	9031210740-SH74-0108	20	4000	OP1	3100	155
5904441711974	9031150740-SH74-0108	25	4000	OP1	3875	155
5904441711981	9031010740-SH74-0108	30	4000	OP1	4650	155
5904441711998	9031220740-SH74-0108	35	4000	OP1	5425	155
5904441712001	9031020740-SH74-0108	40	4000	OP1	6200	155
5904441712018	9031030740-SH74-0108	50	4000	OP1	7750	155
5904441712025	9031230740-SH74-0108	60	4000	OP1	9300	155
5904441712032	9031040740-SH74-0108	70	4000	OP1	10850	155
5904441712049	9031210740-SH74-0208	20	4000	OP2	3100	155
5904441712056	9031150740-SH74-0208	25	4000	OP2	3875	155
5904441712063	9031010740-SH74-0208	30	4000	OP2	4650	155
5904441712070	9031220740-SH74-0208	35	4000	OP2	5425	155
5904441712087	9031020740-SH74-0208	40	4000	OP2	6200	155
5904441712094	9031030740-SH74-0208	50	4000	OP2	7750	155
5904441712100	9031230740-SH74-0208	60	4000	OP2	9300	155
5904441712117	9031040740-SH74-0208	70	4000	OP2	10850	155
5904441712124	9031210740-SH74-0308	20	4000	OP3	3100	155
5904441712131	9031150740-SH74-0308	25	4000	OP3	3875	155
5904441712148	9031010740-SH74-0308	30	4000	OP3	4650	155
5904441712155	9031220740-SH74-0308	35	4000	OP3	5425	155
5904441712162	9031020740-SH74-0308	40	4000	OP3	6200	155
5904441712179	9031030740-SH74-0308	50	4000	OP3	7750	155
5904441712186	9031230740-SH74-0308	60	4000	OP3	9300	155
5904441712193	9031040740-SH74-0308	70	4000	OP3	10850	155
5904441712209	9031210740-SH74-0408	20	4000	OP4	3100	155
5904441712216	9031150740-SH74-0408	25	4000	OP4	3875	155
5904441712223	9031010740-SH74-0408	30	4000	OP4	4650	155
5904441712230	9031220740-SH74-0408	35	4000	OP4	5425	155
5904441712247	9031020740-SH74-0408	40	4000	OP4	6200	155
5904441712254	9031030740-SH74-0408	50	4000	OP4	7750	155
5904441712261	9031230740-SH74-0408	60	4000	OP4	9300	155
5904441712278	9031040740-SH74-0408	70	4000	OP4	10850	155
5904441712285	9031210740-SH74-0508	20	4000	OP5	3100	155
5904441712292	9031150740-SH74-0508	25	4000	OP5	3875	155
5904441712308	9031010740-SH74-0508	30	4000	OP5	4650	155
5904441712315	9031220740-SH74-0508	35	4000	OP5	5425	155
5904441712322	9031020740-SH74-0508	40	4000	OP5	6200	155
5904441712339	9031030740-SH74-0508	50	4000	OP5	7750	155
5904441712346	9031230740-SH74-0508	60	4000	OP5	9300	155
5904441712353	9031040740-SH74-0508	70	4000	OP5	10850	155
5904441712360	9031210740-SH74-0608	20	4000	OP6	3100	155
5904441712377	9031150740-SH74-0608	25	4000	OP6	3875	155
5904441712384	9031010740-SH74-0608	30	4000	OP6	4650	155
5904441712391	9031220740-SH74-0608	35	4000	OP6	5425	155
5904441712407	9031020740-SH74-0608	40	4000	OP6	6200	155
5904441712414	9031030740-SH74-0608	50	4000	OP6	7750	155
5904441712421	9031230740-SH74-0608	60	4000	OP6	9300	155
5904441712438	9031040740-SH74-0608	70	4000	OP6	10850	155

model: VIA L

5904441712445	9041240740-SH74-0108	80	4000	OP1	12400	155
5904441712452	9041050740-SH74-0108	90	4000	OP1	13950	155
5904441712469	9041200740-SH74-0108	100	4000	OP1	15500	155
5904441714692	9041060740-SH74-0108	110	4000	OP1	16940	155
5904441714708	9041330740-SH74-0108	120	4000	OP1	18240	155
5904441714715	9041070740-SH74-0108	130	4000	OP1	19500	155
5904441712476	9041240740-SH74-0208	80	4000	OP2	12400	155
5904441712483	9041050740-SH74-0208	90	4000	OP2	13950	155
5904441712490	9041200740-SH74-0208	100	4000	OP2	15500	155
5904441714722	9041060740-SH74-0208	110	4000	OP2	16940	155
5904441714739	9041330740-SH74-0208	120	4000	OP2	18240	155
5904441714678	9041070740-SH74-0208	130	4000	OP2	19500	155
5904441712506	9041240740-SH74-0308	80	4000	OP3	12400	155
5904441712513	9041050740-SH74-0308	90	4000	OP3	13950	155
5904441712520	9041200740-SH74-0308	100	4000	OP3	15500	155
5904441714746	9041060740-SH74-0308	110	4000	OP3	16940	155
5904441714753	9041330740-SH74-0308	120	4000	OP3	18240	155
5904441714760	9041070740-SH74-0308	130	4000	OP3	19500	155
5904441712537	9041240740-SH74-0408	80	4000	OP4	12400	155
5904441712544	9041050740-SH74-0408	90	4000	OP4	13950	155
5904441712551	9041200740-SH74-0408	100	4000	OP4	15500	155
5904441714777	9041060740-SH74-0408	110	4000	OP4	16940	155
5904441714784	9041330740-SH74-0408	120	4000	OP4	18240	155
5904441714791	9041070740-SH74-0408	130	4000	OP4	19500	155
5904441712568	9041240740-SH74-0508	80	4000	OP5	12400	155
5904441712575	9041050740-SH74-0508	90	4000	OP5	13950	155
5904441712582	9041200740-SH74-0508	100	4000	OP5	15500	155
5904441714807	9041060740-SH74-0508	110	4000	OP5	16940	155
5904441714814	9041330740-SH74-0508	120	4000	OP5	18240	155
5904441714821	9041070740-SH74-0508	130	4000	OP5	19500	155
5904441712599	9041240740-SH74-0608	80	4000	OP6	12400	155
5904441712605	9041050740-SH74-0608	90	4000	OP6	13950	155
5904441712612	9041200740-SH74-0608	100	4000	OP6	15500	155
5904441714951	9041060740-SH74-0608	110	4000	OP6	16940	155
5904441714968	9041330740-SH74-0608	120	4000	OP6	18240	155
5904441714975	9041070740-SH74-0608	130	4000	OP6	19500	155

Całkowity strumień świetlny oprawy zmierzony za kloszem przy temp. otoczenia +25°C. Tolerancja strumienia świetlnego +/- 10%. Pomiar fotometryczny został wykonany zgodnie z wymaganiami normy PN-EN13032. / The total luminous flux of the luminaire measured diffuser +25°C. Luminous flux tolerance +/- 10%. Photometric measurement were examined in accordance with the PN-EN13032 system. / Gesamtlichtstrom der Leuchte, gemessen hinter der Abdeckung +25°C. Lichtstrom-Toleranz +/- 10%. Photometrische Messungen wurden nach PN-EN13032 Norm geprüft.

OPCJE DO WYBORU / OPTIONS / OPTIONSWAHL MÖGLICH:

KOD / CODE	OPIS / DESCRIPTION / BEZEICHNUNG		
10kV	Dodatkowe zabezpieczenie przeciwprzepięciowe 10kV	Additional Surge protection 10kV	Zusätzlicher Überspannungsschutz 10kV
SAFE	Złącze "nożowe" - rozłącznik bezpieczeństwa	Disconnect Knife Switch	Trennen Sie den Messerschalter
ZHAGA	Gniazdo ZHAGA	ZHAGA Socket	ZHAGA-Buchse
PZ	Przewód zasilający	Power cable	Stromkabel
PZZH	Przewód zasilający ze złączem hermetycznym	Power cable with hermetic connector	Stromkabel mit hermetischem Verbindung
astroDIM	Automatyczna redukcja mocy oprawy w wybranych godzinach nocnych	Automatic reduction of luminaire power during selected night hours	Automatische Reduzierung der Leuchtenleistung während ausgewählter Nachtstunden
astroDIM+	Współpraca ze sterownikami/programatorami microBLUE, midiBLUE, CPAnet	Cooperation with microBLUE, midiBLUE, CPAnet controllers/programmers	Zusammenarbeit mit microBLUE, midiBLUE, CPAnet Controllern/Programmierern



MILOO-ELECTRONICS Sp z o. o.
Stary Wiśnicz 289
32-720 Nowy Wiśnicz

tel: +48 14 662 19 55
e-mail: biuro@emiloo.pl
www.emiloo.pl



FOTOMETRIA / PHOTOMETRY / PHOTOMETRIE:

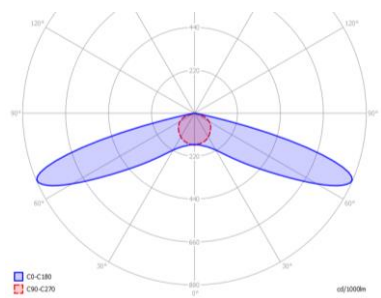

OP1

jezdnie dwupasmowe,
chodniki, ścieżki, deptaki

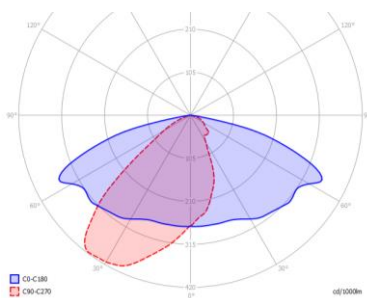

OP2

drogi klasy M w których szerokość drogi jest
równa lub większa od wysokości stupa

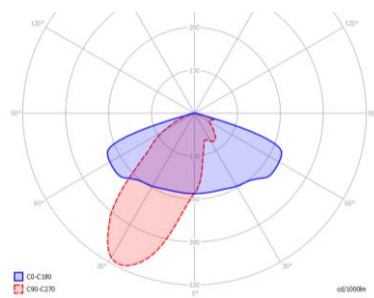

OP3

drogi klasy M w których szerokość drogi jest
równa lub mniejsza od wysokości stupa

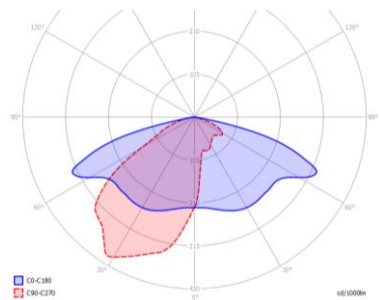

OP4

IESNA typ III drogi równe lub szersze niż
wysokość stupa, poliweglan

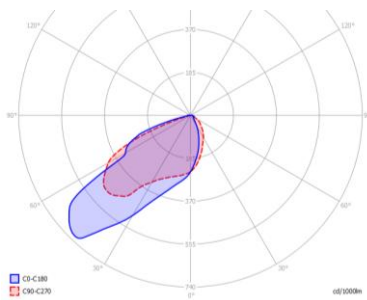

OP5

przejścia dla pieszych

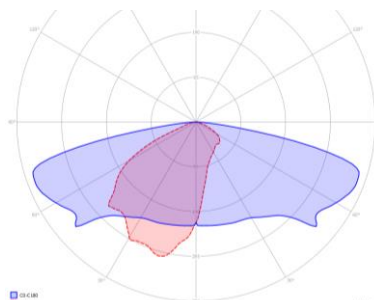

OP6

Drogi klasy S, rozsył światła między II a III typem
IESNA

MAKS. LICZBA OPRAW NA BEZPIECZNIK: / MAX. NO. OF LUMINAIRES PER FUSE / MAX. ANZAHL DER LEUCHTEN PRO SICHERUNG:

MODEL / MODEL / MODELL	WARIANT / VERSION / VARIANTE	MOC / POWER / LEISTUNG	MAKSYMALNA ILOŚĆ OPRAW Z BEZPIECZNIKIEM / MAX. NO. OF LUMINAIRES PER FUSE / MAX. ANZAHL LEUCHTEN PRO SICHERUNG (szt. / pcs. /Stk.)
VIA-M	Standard	20W - 40W	B6 = 13 / B10 = 20 / B16 = 32 / B25 = 50 / C16 = 54 / C25 = 83
		45W - 70W	B6 = 4 / B10 = 6 / B16 = 10 / B25 = 15 / C16 = 17 / C25 = 26
	ZHAGA (DALI, D4i)	20W - 40W	B6 = 12 / B10 = 19 / B16 = 30 / B25 = 47 / C16 = 51 / C25 = 78
		45W - 70W	B6 = 17 / B10 = 26 / B16 = 42 / B25 = 65 / C16 = 71 / C25 = 109
VIA-L	Standard	75W - 100W	B6 = 4 / B10 = 6 / B16 = 10 / B25 = 15 / C16 = 17 / C25 = 26
		105W - 130W	B6 = 3 / B10 = 4 / B16 = 7 / B25 = 11 / C16 = 12 / C25 = 18
	ZHAGA (DALI, D4i)	75W - 100W	B6 = 10 / B10 = 16 / B16 = 26 / B25 = 40 / C16 = 44 / C25 = 67
		105W - 130W	B6 = 5 / B10 = 9 / B16 = 14 / B25 = 22 / C16 = 24 / C25 = 36

NAME	L1 [mm]	L2 [mm]	W [mm]	H [mm]	[kg]
VIA M	625	500	240	108	5,2
VIA L	725	600	300	113	7,4

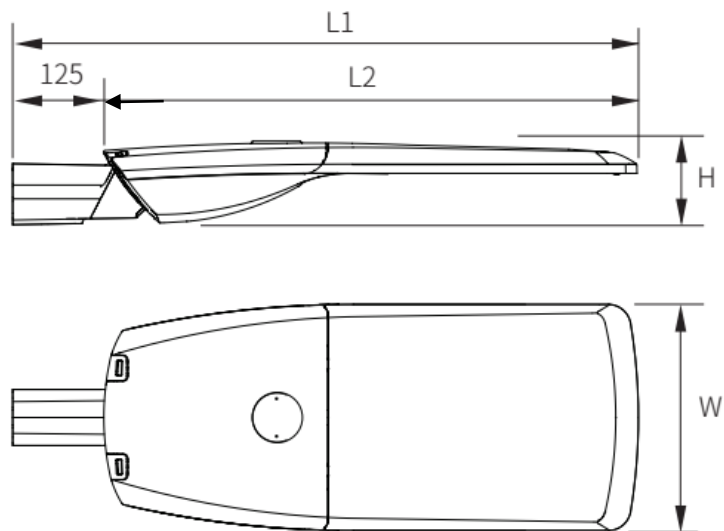

Rysunek oprawy z zamontowanym w korpusie gniazdem ZHAGA /
 A drawing of the luminaire with a ZHAGA socket mounted in the housing. /
 Eine Zeichnung der Leuchte mit einer im Gehäuse montierten ZHAGA-Buchse

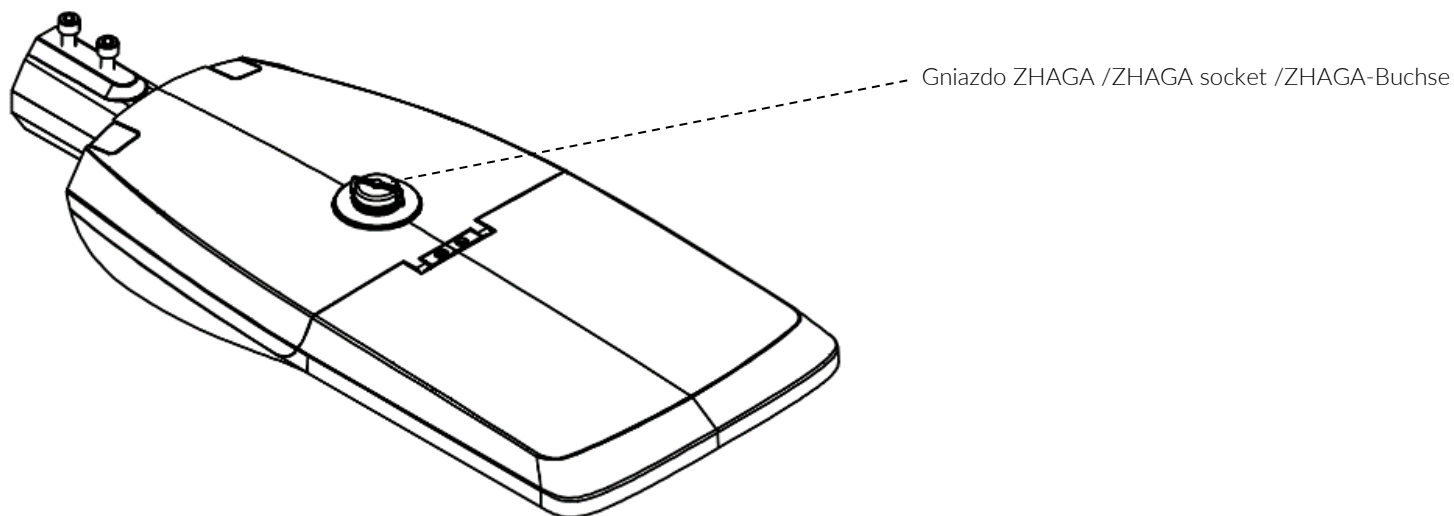



Deklarowana trwałość dotyczy opraw pracujących w temperaturze otoczenia +45°C przy zapewnionych optymalnych warunkach wentylacji. / The declared lifetime applies to fixtures operating at an ambient temperature of +45°C with ensured optimal ventilation conditions. / Die erklärte Lebensdauer bezieht sich auf Leuchten, die bei einer Raumtemperatur von +45°C und optimalen Lüftungsbedingungen arbeiten.

*Podany zakres regulacji kąta nachylania uwzględnia montaż na uchwycie zamontowanym pionowo oraz poziomo. / The specified tilt angle adjustment range takes into account installation on a vertically and horizontally mounted bracket. / Der angegebene Neigungswinkel-Einstellbereich berücksichtigt die Montage an einer vertikal und horizontal montierten Halterung.

W związku z ciągłym rozwojem produktów zastrzegamy sobie prawo do wprowadzania zmian konstrukcyjnych w oprawach oraz aktualizowania parametrów. / Due to continuous product development, we reserve the right to introduce structural changes in the fixtures and to update their parameters. / Aufgrund der ständigen Produktentwicklung behalten wir uns das Recht vor, technische Änderungen und Aktualisierung von Parametern an Leuchten vorzunehmen.

Data aktualizacji / Revision Date / Datum der letzten Aktualisierung:
27.02.2025

LEGENDA / LEGEND / LEGENDE:



Deklaracja zgodności
Declaration of conformity
EG-Konformitätserklärung



Źródło światła LED
LED source
LED Quelle



Kod produktu
Code
Artikelnummer



Kąt rozsyłu światłości
Light distribution angle
Winkel der Lichtverteilung



Strumień świetlny
Luminous flux
Lichtstrom



Kolor oprawy
Luminaire color
Leuchte Farbe



Wskaźnik ośnienia przykrego
Glare indicator
Blendungsanzeige



Standard Zhaga D4i
ZHAGA D4i standard
ZHAGA D4i-Standard



Klasa ochronności II
Protection class II
Schutzklasse II



Stopień ochrony IP
IP protection marking
Schutzklasse IP



Rodzaj klosza
Cover
Abdeckung



Wymiary
Dimensions
Masse



Skuteczność świetlna
Luminous efficiency
Lichtausbeute der Leuchte



Waga
Weight
Gewicht



Certyfikat ENEC
ENEC certificate
ENEC-Zertifikat



Funkcja sterowania AstroDIM
AstroDIM control function
AstroDIM Steuerfunktion



Napięcie zasilania
Power supply
Speisespannung



Dyrektywa RoHS
The RoHS Directive
RoHS Richtlinie



Atest higieniczny PZH
Hygiene certificate of the NIH
Attest von Polnischer Hygieneanstalt



Moc oprawy
Luminaire power
Leistung der Leuchte



Temperatura barwowa
Color temperature
Farbtemperatur



System sterowania DALI
DALI control system
Steuersystem DALI



Certyfikat ENEC+
ENEC+ certificate
ENEC+-Zertifikat