

# I-SPOT SPECIAL



## PL

Oprawa I-SPOT SPECIAL jest kierunkową oprawą LED montowaną na szynoprzewodzie przeznaczoną do oświetlania żywności. Do wyboru modele zaprojektowane do oświetlania mięsa, pieczywa, ryb, serów, warzyw i owoców, alkoholi lub ubrań. Każdy model dostępny w czterech wariantach optyki (20°, 30°, 40°, 50°). Oprawa dostępna w kolorze białym.

## EN

The I-SPOT SPECIAL luminaire is a directional rail-mounted LED luminaire designed for food lighting. A choice of models designed to illuminate meat, bread, fish, cheese, fruit and vegetables, alcohol or clothing. Each model available in four optics (20o, 30o, 40o, 50o). Luminaire available in white.

## DE

Die I-SPOT SPECIAL-Leuchte ist eine gerichtete LED-Schienenleuchte für die Beleuchtung von Lebensmitteln. Eine Auswahl an Modellen für die Beleuchtung von Fleisch, Brot, Fisch, Käse, Obst und Gemüse, Alkohol oder Kleidung. Jedes Modell ist in vier Optiken erhältlich (20o, 30o, 40o, 50o). Die Leuchte ist in Weiß erhältlich.

### OPCJE DO WYBORU / OPTIONS / OPTIONSWAHL MÖGLICH:



SC



MEAT\*\* BREAD\*\* FISH\*\*  
CHEESE\*\* VEG-FRU\*\* ALCO-W\*\*  
ALCO-C\*\* CLOTHES\*\*



20° 40°  
30° 50°



biały/white/weiß  
inny/different/andere\*\*

SC - szyba clear hartowana/ clear tempered glass / klares gehärtetes Glas

\*\*Opcje dostępne na zamówienie po konsultacji z działem handlowym. / Options available on request, following consultation with the sales department. / Andere Optionen auf Bestellung nach der Beratung mit der Handelsabteilung erhältlich.

## PL

### PARAMETRY TECHNICZNE

Sposób montażu: na szynoprzewodzie, natynkowy\*\*  
Obudowa: ABS i aluminium  
LED: 3 elipsa MacAdama (SDCM 3)  
Napięcie zasilania: 220-240 V / 50 Hz  
Współczynnik mocy (PF): 0,99  
Poziom zakłóceń harmoniczných THD < 5%  
Klasa ochronności: I  
Stopień ochrony: IK07  
Stopień szczelności: IP40  
Temperatura otoczenia: od 0°C do +35°C  
Wilgotność otoczenia: 20-80%  
Trwałość (L70B10): 50 000 h

**ZASTOSOWANIE:** obiekty handlowe

## EN

### TECHNICAL PARAMETERS

Mounting: on track, surface mounting\*\*  
Body: ABS and aluminium  
LED: MacAdam 3 ellipse (SDCM 3)  
Power Supply: 220-240 V / 50 Hz  
Power factor (PF): 0,99  
Harmonic distortion THD < 5%  
Protection class: I  
Protection marking: IK07  
Protection marking: IP40  
Ambient temperature: from 0°C to +35°C  
Ambient humidity: 20-80%  
Lifetime (L70B10): 50 000 h

**APPLICATION:** commercial buildings

## DE

### TECHNISCHE DATEN

Montageart: für raupen ausgelegt, zur Aufputz-Montage\*\*  
Gehäuse: ABS und Aluminium  
LED: MacAdam 3-Ellipse (SDCM 3)  
Speisespannung: 220-240 V / 50 Hz  
Leistungsfaktor (PF): 0,99  
Harmonische Verzerrung THD < 5%  
Schutzklasse: I  
Schutzklasse: IK07  
Schutzklasse: IP40  
Umgebungstemperatur: von 0°C bis +35°C  
Umgebungsluftfeuchtigkeit: 20-80%  
Lebensdauer (L70B10): 50 000 h

**EINSATZBEREICH:** Handelsobjekte

Deklarowana trwałość dotyczy opraw pracujących w temperaturze otoczenia +25°C przy zapewnionych optymalnych warunkach wentylacji. / The declared lifetime applies to fixtures operating at an ambient temperature of +25°C with ensured optimal ventilation conditions. / Die erklärte Lebensdauer bezieht sich auf Leuchten, die bei einer Raumtemperatur von +25°C und optimalen Lüftungsbedingungen arbeiten.

\* Spełnienie warunku UGR<19 w sensie normy PN-EN 12464-1:2012 jest wymagane dla konkretnego projektu oświetleniowego i zależy od aktualnych warunków oświetleniowych / Compliance with UGR <19 in the sense of PN-EN 12464-1: 2012 is required for a specific lighting project and depends on current lighting conditions / Die Einhaltung von UGR <19 im Sinne von PN-EN 12464-1: 2012 ist für ein bestimmtes Beleuchtungsprojekt erforderlich und hängt von den aktuellen Lichtverhältnissen ab



EAN	CODE	[W]	[K]	[°]	[lm]	[lm/W]	
-----	------	-----	-----	-----	------	--------	--

Typ: DALI, biała / Type: DALI, white / Art: DALI, weiß

**Typ: Mięso / Type: Meat / Art: Fleisch**

5902194098106	049400DMEA-SC00-0008	35	MEAT	SC	20	2000	57	DALI
5902194098113	049400DMEA-SC00-0108	35	MEAT	SC	30	2000	57	DALI
5902194098120	049400DMEA-SC00-0208	35	MEAT	SC	40	2000	57	DALI
5902194098137	049400DMEA-SC00-0308	35	MEAT	SC	50	2000	57	DALI

**Typ: Pieczywo / Type: Bread / Art: Backware**

5902194098144	049400DBRE-SC00-0008	35	BREAD	SC	20	2900	83	DALI
5902194098151	049400DBRE-SC00-0108	35	BREAD	SC	30	2900	83	DALI
5902194098168	049400DBRE-SC00-0208	35	BREAD	SC	40	2900	83	DALI
5902194098175	049400DBRE-SC00-0308	35	BREAD	SC	50	2900	83	DALI

**Typ: Ryby / Type: Fish / Art: Fische**

5902194098182	049400DFIS-SC00-0008	35	FISH	SC	20	3200	91	DALI
5902194098199	049400DFIS-SC00-0108	35	FISH	SC	30	3200	91	DALI
5902194098205	049400DFIS-SC00-0208	35	FISH	SC	40	3200	91	DALI
5902194098212	049400DFIS-SC00-0308	35	FISH	SC	50	3200	91	DALI

**Typ: Sery / Type: Cheese / Art: Käse**

5902194098229	049400DCHE-SC00-0008	35	CHEESE	SC	20	3000	86	DALI
5902194098236	049400DCHE-SC00-0108	35	CHEESE	SC	30	3000	86	DALI
5902194098243	049400DCHE-SC00-0208	35	CHEESE	SC	40	3000	86	DALI
5902194098250	049400DCHE-SC00-0308	35	CHEESE	SC	50	3000	86	DALI

**Typ: Warzywa i owoce / Type: Vegetables and fruits / Art: Gemüse und Obst**

5902194098267	049400DVEF-SC00-0008	35	VEG-FRU	SC	20	3000	86	DALI
5902194098274	049400DVEF-SC00-0108	35	VEG-FRU	SC	30	3000	86	DALI
5902194098281	049400DVEF-SC00-0208	35	VEG-FRU	SC	40	3000	86	DALI
5902194098298	049400DVEF-SC00-0308	35	VEG-FRU	SC	50	3000	86	DALI

**Typ: Alkohol-biały / Type: Alcohol-white / Art: Alkohol-weiß**

5902194098304	049400DALW-SC00-0008	35	ALCO-W	SC	20	3200	91	DALI
5902194098311	049400DALW-SC00-0108	35	ALCO-W	SC	30	3200	91	DALI
5902194098328	049400DALW-SC00-0208	35	ALCO-W	SC	40	3200	91	DALI
5902194098335	049400DALW-SC00-0308	35	ALCO-W	SC	50	3200	91	DALI

**Typ: Alkohol-kolorowy / Type: Alcohol-colour / Art: Alkohol-farbig**

5902194098342	049400DALC-SC00-0008	35	ALCO-C	SC	20	3000	86	DALI
5902194098359	049400DALC-SC00-0108	35	ALCO-C	SC	30	3000	86	DALI
5902194098366	049400DALC-SC00-0208	35	ALCO-C	SC	40	3000	86	DALI
5902194098373	049400DALC-SC00-0308	35	ALCO-C	SC	50	3000	86	DALI

**Typ: Ubrania / Type: clothes / Art: Kleidung**

5902194098380	049400DCLO-SC00-0008	35	CLOTHES	SC	20	3000	86	DALI
5902194098397	049400DCLO-SC00-0108	35	CLOTHES	SC	30	3000	86	DALI
5902194098403	049400DCLO-SC00-0208	35	CLOTHES	SC	40	3000	86	DALI
5902194098410	049400DCLO-SC00-0308	35	CLOTHES	SC	50	3000	86	DALI

Całkowity strumień świetlny oprawy zmierzony za kloszem przy temp. otoczenia +25°C. Tolerancja strumienia świetlnego +/- 10%. Pomiary fotometryczne zostały wykonane zgodnie z wymaganiami normy PN-EN13032. / The total luminous flux of the luminaire measured diffuser +25°C. Luminous flux tolerance +/- 10%. Photometric measurement were examined in accordance with the PN-EN13032 system. / Gesamtlichtstrom der Leuchte, gemessen hinter der Abdeckung +25°C. Lichtstrom-Toleranz +/- 10%. Photometrische Messungen wurden nach PN-EN13032 Norm geprüft.

FOTOMETRIA / PHOTOMETRY / PHOTOMETRIE:

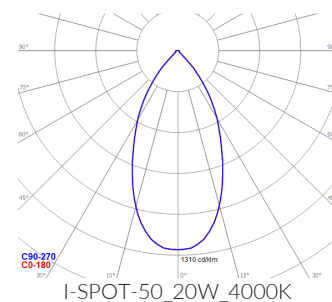
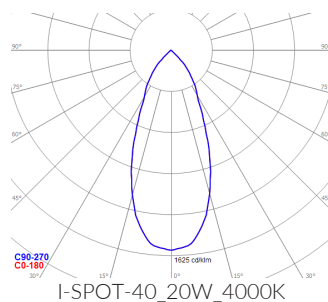
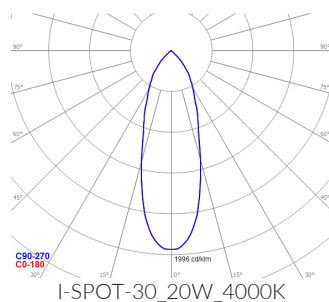
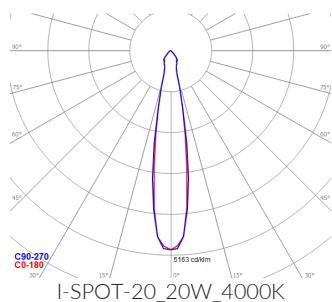

WYMIARY / DIMENSIONS / MASSE:



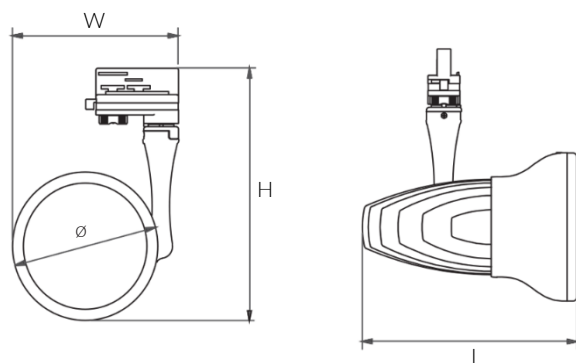



















NAME	L [mm]	W [mm]	H [mm]	ø [mm]	[kg]
I-SPOT SPECIAL	216	166	248	146	1,0



W związku z ciągłym rozwojem produktów zastrzegamy sobie prawo do wprowadzania zmian konstrukcyjnych w oprawkach oraz aktualizowania parametrów.  
 Due to continuous product development, we reserve the right to introduce structural changes in the fixtures and to update their parameters.  
 Aufgrund der ständigen Produktentwicklung behalten wir uns das Recht vor, technische Änderungen und Aktualisierung von Parametern an Leuchten vorzunehmen.

Data aktualizacji / Revision Date / Datum der letzten Aktualisierung: 14.07.2023

LEGENDA / LEGEND / LEGENDE:

	Deklaracja zgodności Declaration of conformity EG-Konformitätserklärung		Klasa ochronności I Protection class I Schutzklasse I		Napięcie zasilania Power supply Speisespannung
	Źródło światła LED LED source LED Quelle		Technologia stałego strumienia świetlnego Constant luminous flux technology Konstante Lichtstromtechnologie		Dyrektywa RoHS The RoHS Directive RoHS Richtlinie
	Wymiary montażowe Mounting dimensions Montagemaße		Stopień szczelności IP IP protection marking Schutzklasse IP		Atest higieniczny PZH Hygiene certificate of the NIH Attest von Polnischer Hygieneanstalt
	Kod produktu Code Artikelnummer		Rodzaj klosza Cover Abdeckung		Moc oprawy Luminaire power Leistung der Leuchte
	Kąt rozsyłu światłości Light distribution angle Winkel der Lichtverteilung		Wymiary Dimensions Masse		Temperatura barwowa Color temperature Farbtemperatur
	Strumień świetlny Luminous flux Lichtstrom		Skuteczność świetlna Luminous efficiency Lichtausbeute der Leuchte		System sterowania DALI DALI control system Steuersystem DALI
	Kolor oprawy Luminaire color Leuchte Farbe		Waga Weight Gewicht		Nazwa produktu Product name Produktname
	Wskaźnik ośnienia przykrego Glare indicator Blendungsanzeige				